

YE-160XPFO DIN PLUG PANEL MOUNT SCREW LOCKING

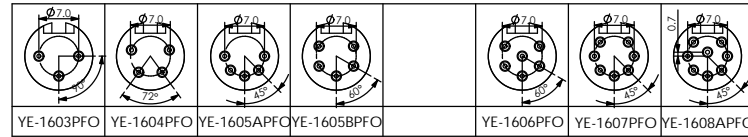

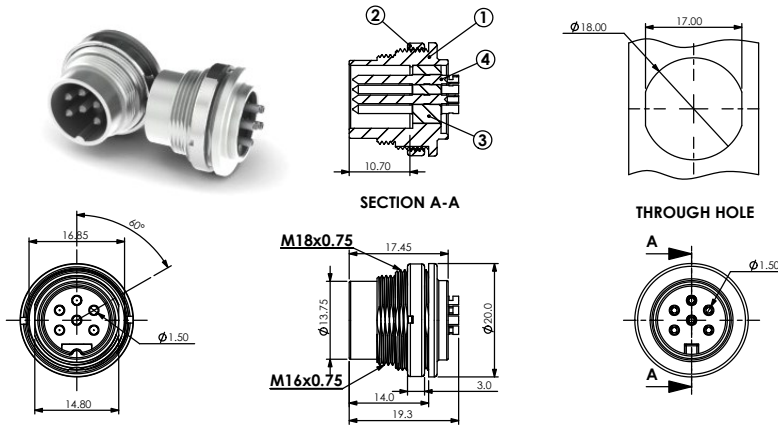



MATERIAL :

1. SHIELD COVER :
Zn ALLOY NICKEL PTD.
2. SCREW NUT : BRASS NICKEL PTD.
3. HOUSING : PA66+GF
4. TERMINALS : BRASS SILVER PTD.

SPECIFICATION :

Rating : 100V AC 1A max.
 Contact Resistance :
 Pins 30mΩ max.
 Shell 50mΩ max.
 Insulation Resistance :
 100MΩ at 500V DC min.
 Voltage Withstand :
 250V AC for 1 minute

		
YE-1603PFO	YE-1604PFO	YE-1605APFO
		
YE-1605BPFO		YE-1606PFO
		
YE-1607PFO	YE-1608APFO	